







CENNÍK	PRE:	Koncový predaj	KP
---------------	------	-----------------------	-----------

KOMOROVÉ PLATNE				Mob.: +421 949 357 030 Mob.: +421 948 700 875			
platnosť od:	11.4.2022	Radoslav Martoš - PPProdukt, Suchý potok 575/2, 972 42 Lehota pod Vtáčnikom					
kód	hrúbka	šírka	dĺžka	štruktúra	farba	EUR/m ² bez DPH	EUR/m ² s DPH

CARBOPLAK (1UV = jednostranná alebo 2UV = obojstranná UV ochrana, komorová polykarbonátová platňa)									
CBK1UV4/2W/800-transparent	4 mm	2100 mm	6 m		2W = 1 komorový	číry	7,06	8,47	
CBK1UV4/2W/800-BK04bronz	4 mm					bronz	7,41	8,89	
CBK1UV4/2W/800-OK04opal	4 mm					opal	7,41	8,89	
CBK1UV6/2W/1300-transparent	6 mm					číry	11,48	13,78	
CBK1UV6/2W/1300-BK04bronz	6 mm					bronz	12,06	14,47	
CBK1UV6/2W/1300-OK04opal	6 mm					opal	12,06	14,47	
CBK1UV8/2W/1500-transparent	8 mm					číry	13,25	15,90	
CBK1UV8/2W/1500-BK04bronz	8 mm					bronz	13,91	16,69	
CBK1UV8/2W/1500-OK04opal	8 mm		opal	13,91	16,69				
CBK1UV10/2W/1600-transparent	10 mm		4 a 5 m 6 a 7 m				číry	14,13	16,96
CBK1UV10/2W/1600-BK04bronz	10 mm						bronz	14,83	17,80
CBK1UV10/2W/1600-OK04opal	10 mm		4 a 5 m 6 a 7 m				opal	14,83	17,80
CBK2UV16/7W/2550-transparent	16 mm						číry	22,52	27,02
CBK2UV16/7W/2550-BK03bronz	16 mm		4 a 5 m 6 a 7 m				bronz	23,64	28,37
CBK2UV16/7W/2550-OK04opal	16 mm						opal	23,64	28,37
CBK2UV20/7W/2900-transparent	20 mm		6 a 7 m				číry	25,61	30,73
CBK2UV20/7W/2900-OK04opal	20 mm	opal					26,89	32,27	

Lexan™ Thermoclear™ Plus (2UV = obojstranná UV ochrana, komorová polykarbonátová platňa)										
LT2UV4.5/2RS/1000-112	4,5 mm	2100 mm	6 m		2RS = 1 komorový	číry	9,86	11,83		
LT2UV6/2RS/1300-112	6 mm	1200 a 2100 mm	6 a 7 m			číry	12,21	14,65		
LT2UV6/2RS/1300-515055	6 mm	2100 mm	6 m			bronz	13,08	15,70		
LT2UV6/2RS/1300-WH7A092X	6 mm					opal	12,81	15,37		
LT2UV8/2RS/1500-112	8 mm	2100 mm	6 a 7 m			číry	14,10	16,92		
LT2UV8/2RS/1500-515055	8 mm					bronz	15,09	18,11		
LT2UV8/2RS/1500-WH7A092X	8 mm					opal	14,81	17,77		
LT2UV10/2RS/1700-112	10 mm	1200 mm	6 a 7 m					číry	15,97	19,16
LT2UV10/2RS/1700-515055	10 mm	1500* mm						bronz	17,08	20,50
LT2UV10/2RS/1700-WH7A092X	10 mm	2100 mm	4 / 5 / 6 a 7 m				5RS = 4 komorový	opal	16,78	20,14
LT2UV10/5RS/1750-112	10 mm	2100 mm	6 a 7 m	číry	16,43			19,72		
LT2UV10/5RS/1750-WH7A092X	10 mm			opal	17,26			20,71		
LT2UVIR10/5RS/1750-GN8B038T	10 mm	2100 mm	5 / 6 a 7 m	zelený scIR	21,76			26,11		
LT2UV16/5X/2600-112	16 mm	2100 mm	4 / 5 / 6 a 7 m		5 X - štruktúra	číry	24,42	29,30		
LT2UV16/5X/2600-515055	16 mm					bronz	26,13	31,36		
LT2UV16/5X/2600-WH7A092X	16 mm					opal	25,65	30,78		
LT2UVIR16/5X/2600-GN8B038T	16 mm					2100 mm	5 / 6 a 7 m	zelený scIR	32,32	38,78
LT2UV25/5X/3400-112	25 mm					2100 mm	6 a 7 m	číry	31,94	38,33
LT2UV25/5X/3400-WH7A092X	25 mm	2100 mm	6 a 7 m	opal	33,53	40,24				
LT2UV32/5X/3800-112	32 mm	1200 mm	6 a 7 m		9 X - štruktúra	číry	37,48	44,98		
LT2UV16/9X/2500-WH7A092X	16 mm	2095 mm	6 a 7 m			opal	24,66	29,59		
LT2UV25/9X/3000-112	25 mm					číry	28,18	33,82		
LT2UV25/9X/3000-WH7A092X	25 mm			opal	29,59	35,51				
* aj šírka 1500 mm = s príplatkom 10%						zelený scIR = vyššia redukcia slnečného žiarenia				

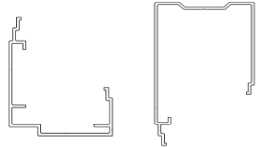
Lexan™ Thermoclick (1UV, spoj na pero - drážku, komorová polykarbonátová platňa)							
LTC40/4X/4000-112	40 mm	500 mm	6 m 7 m		číry	48,31	57,97
AL U40DB-203	spodný profil		6,5 m		bez pú	11,13	13,36
AL U40HB-202	horný a bočný profil		6,5 m		bez pú	11,05	13,26
Thclic príchytká AL	fixácia spoju LTC40		ks		bez pú	1,75	2,10
Tesnenie G40	8 x 12 mm		bm		čierna	0,83	1,00

PLNÉ PLATNE



Mob.: +421 949 357 030

Mob.: +421 948 700 875

platnosť od:	11.4.2022	Radoslav Martoš - PPProdukt, Suchý potok 575/2, 972 42 Lehota pod Vtáčnikom					
kód	hrúbka	šírka	dĺžka	štruktúra	farba	EUR/m ² bez DPH	EUR/m ² s DPH

Lexan™ CLINIWALL (odolné OBKLADOVÉ platne na stenu do interiéru)

Cliniwall C6206-1,7-WH6G057	1,7 mm	1300 mm	3050 mm	semiš (vzhľad povrchu)	biela	38,60	46,32
Cliniwall C6206-1,7-GY7G160	1,7 mm	1300 mm	3050 mm	semiš (vzhľad povrchu)	bledošedá	38,60	46,32
Cliniwall C6206-1,7-GY8G179	1,7 mm	1300 mm	3050 mm	semiš (vzhľad povrchu)	bledošedá béžová	38,60	46,32

Lexan™ 9030 (technický plný polykarbonát, bez UV ochrany, do interiéru)

9030-0.75-112	0,75 mm	1250 x 2050 mm		čírý	9,44	11,33
9030-1-112	1 mm	1250 x 2050 mm		čírý	12,37	14,84
9030-1.5-112	1,5 mm	1250 x 2050 mm		čírý	18,19	21,83
9030-2-112	2 mm	1250 x 2050 mm / 2050 x 3050 mm		čírý	20,81	24,97
9030-3-112	3 mm	1250 x 2050 mm / 2050 x 3050 mm		čírý	31,22	37,46

Lexan™ Exell D (plný polykarbonát, 2UV = obojstranná UV ochrana, do exteriéru)

Exell D-2-112	2 mm	2050 x 3050 mm		čírý	21,90	26,28
Exell D-3-112	3 mm	2050 x 3050 mm		čírý	32,86	39,43
Exell D-3-5109	3 mm	2050 x 3050 mm		bronz	35,15	42,18
Exell D-3-WH7D2870	3 mm	2050 x 3050 mm / 2050 x 6100 mm		opál LT57%	34,49	41,39
Exell D-4-112	4 mm	2050 x 3050 mm / 2050 x 6100 mm		čírý	43,81	52,57
Exell D-4-5109	4 mm	2050 x 3050 mm / 2050 x 6100 mm		bronz	46,87	56,24
Exell D-4-WH7D2870	4 mm	2050 x 3050 mm / 2050 x 6100 mm		opál LT61%	46,00	55,20
Exell D-5-112	5 mm	2050 x 3050 mm / 2050 x 6100 mm		čírý	54,76	65,71
Exell D-6-112	6 mm	2050 x 3050 mm / 3600 mm / 4600 mm / 6100 mm		čírý	65,71	78,85
Exell D ST-6-112	6 mm	2050 x 3050 mm / 2050 x 6100 mm		čírý textúra	65,73	78,88
Exell D-6-5109	6 mm	2050 x 3050 mm / 3600 mm / 4600 mm / 6100 mm		bronz	70,32	84,38
Exell D-6-GY5E25OT	6 mm	2050 x 3050 mm / 3600 mm / 4600 mm / 6100 mm		šedý	75,57	90,68
Exell D-6-WH7D2870	6 mm	2050 x 3050 mm / 3600 mm / 4600 mm / 6100 mm		opál LT62%	69,00	82,80
Exell D-8-112	8 mm	2050 x 3050 mm / 4000 mm / 4600 mm / 6100 mm		čírý	87,62	105,14
Exell D-8-5109	8 mm	2050 x 3050 mm / 4100 mm / 4600 mm / 6100 mm		bronz	93,75	112,50
Exell D-9,5-112	10 mm	2050 x 3050 mm		čírý	104,04	124,85
Exell D-12-112	12 mm	2050 x 3050 mm		čírý	131,41	157,69
Exell D-15-112	15 mm	2050 x 3050 mm		čírý	164,28	197,14

Lexan™ Margard MR5E (plný polykarbonát 2UV, vytvrdený povrch so zvýšenou odolnosťou, rovné aplikácie)

Margard MR5E-3-112	3 mm	2000 x 3000 mm		čírý	119,68	143,62
Margard MR5E-4-112	4 mm	2000 x 3000 mm		čírý	138,87	166,64
Margard MR5E-5-112	5 mm	2000 x 3000 mm		čírý	159,58	191,50
Margard MR5E-6-112	6 mm	2000 x 3000 mm		čírý	179,50	215,40
Margard MR5E-8-112	8 mm	2000 x 3000 mm		čírý	216,95	260,34
Margard MR5E-9.5-112	10 mm	2000 x 3000 mm		čírý	246,23	295,48
Margard MR5E-12-112	12 mm	2000 x 3000 mm		čírý	296,92	356,30

SOTON (plný polykarbonát, 2UV = obojstranná UV ochrana, do exteriéru)

SPC2UV-3-transparent	3 mm	2050 x 3050 mm		čírý	29,52	35,42
SPC2UV-4-transparent	4 mm	2050 x 3050 mm		čírý	39,36	47,23
SPC2UV-5-transparent	5 mm	2050 x 3050 mm		čírý	49,20	59,04
SPC2UV-6-transparent	6 mm	2050 x 3050 mm a 2100 x 3600 mm / 4600 mm / 6100 mm		čírý	59,04	70,85
SPC2UV-8-transparent	8 mm	2050 x 3050 mm a 2100 x 4000 mm / 4600 mm / 6100 mm		čírý	78,72	94,46

PMMA XT (platňa plexi)

PMMA XT-2-000	2 mm	2050 x 3050 mm		čírý	17,22	20,66
PMMA XT-3-000	3 mm	2050 x 3050 mm		čírý	25,06	30,07
PMMA XT-4-000	4 mm	2050 x 3050 mm		čírý	33,42	40,10
PMMA XT-5-000	5 mm	2050 x 3050 mm		čírý	41,77	50,12
PMMA XT-6-000	6 mm	2050 x 3050 mm		čírý	50,12	60,14





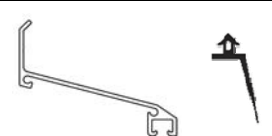

platnosť od:

11.4.2022

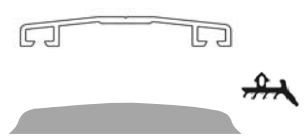
Radoslav Martoš - PPProdukt, Suchý potok 575/2, 972 42 Lehota pod Vtáčnikom

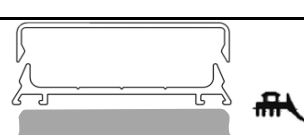
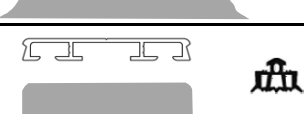
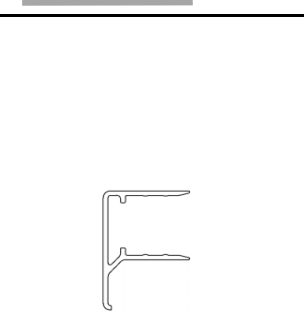
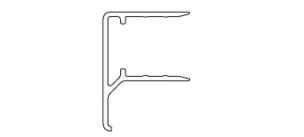
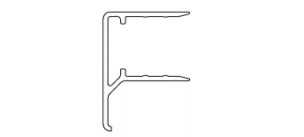
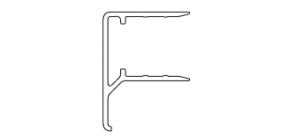
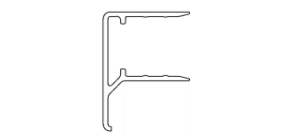
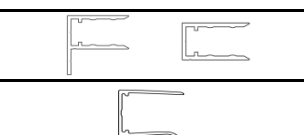
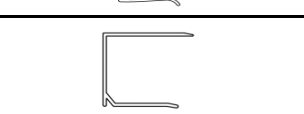
kód	rozmer	dĺžka	obrázok	farba	EUR/m ² bez DPH	EUR/m ² s DPH
STENOVÝ AL Sprofil (na utesnenie prístrešku pri zvislej stene)						
AL Sprofil	46 x 60 mm	2,133 / 3,2 m 4,265 / 6,4 m		bez pu	5,50	6,60
Tesnenie S	17 x 39 mm	balík 73 (bm)		čierna	1,50	1,80
PL krytka 2S	Pár bočných krytiek k S profilu, šedá + 2ks skrutky			šedá	2,35	2,82

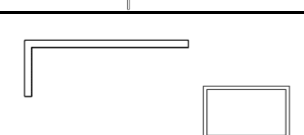
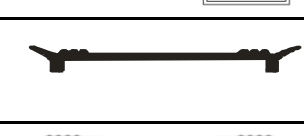
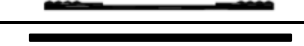
HLINÍKOVÉ PROFILY, tesnenie

AL 60 prítlačná lišta oblá	60 x 9 mm	2 / 3 / 4 m 5 / 6 / 7 m		bez pu	4,00	4,80
AL 60 oblá - BRONZ elox				hnedá	5,22	6,26
AL 60 oblá - RAL7016				antracit	5,22	6,26
Guma ALoblá - čierna	10 x 9 mm	balík 250 m (bm)		čierna	0,63	0,76
PL krytka do AL 60 lišty oblej	plastová krytka			šedá/čierna	0,50	0,60
AL 60 nak. krytka - SILVER elox	61 x 12 mm	3 / 6 m		strieborná	4,72	5,66
AL 60 naklap. spodná	60 x 10 mm	3 / 6 m		bez pu	5,45	6,54
Tesnenie k AL50 - čierne	15 x 8 mm	balík 200 m (bm)		čierna	0,96	1,15
PL krytka do AL 60 nakl. lišty	plastová krytka			šedá	0,66	0,79
AL 50 prítlačná lišta	50 x 7 mm	3 / 4 / 6 / 7 m		bez pu	3,84	4,61
Tesnenie k AL50 - čierne	15 x 12 mm	balík 150 (bm)		čierna	0,96	1,15
PL krytka do AL 50 lišty	plastová krytka			šedá	0,6	0,72
F6 - AL ukončovaci profil	6,2x20,2x21,5mm	2,133 / 3,2 m 4,265 / 6,4 m		bez pu	2,62	3,14
F6 - AL - BRONZ elox				hnedá	3,3	3,96
F6 - AL - RAL7016				antracit	3,3	3,96
F8 - AL ukončovaci profil	8,2x22,2x21,5mm	2,133 / 3,2 m 4,265 / 6,4 m		bez pu	2,72	3,26
F8 - AL - BRONZ elox				hnedá	3,42	4,10
F8 - AL - RAL7016				antracit	3,42	4,10
F10 - AL ukončovaci profil	10,2x24,2x21,5mm	2,133 / 3,2 m 4,265 / 6,4 m		bez pu	2,59	3,11
F10 - AL - BRONZ elox				hnedá	3,52	4,22
F10 - AL - RAL7016				antracit	3,52	4,22
F16 - AL ukončovaci profil	16,2x24,2x21,5mm	2,133 / 3,2 m 4,265 / 6,4 m		bez pu	2,81	3,37
F16 - AL - BRONZ elox				hnedá	3,84	4,61
F16 - AL - RAL7016				antracit	3,84	4,61
F20 - AL ukončovaci profil	20,2x36x21,5mm	2,133 / 3,2 m 4,265 / 6,4 m		bez pu	3,32	3,98
F25 - AL ukončovaci profil	25,2x41x21,5 mm	4,265 / 6,4 m		bez pu	3,52	4,22
F10 - AL108370 rovné	10,2x24x24mm	2,133 / 3,2 m 4,265 / 6,4 m		bez pu	2,8	3,36
U10 - AL108371 rovné	10,2x13,5x24mm	2,133 / 3,2 m 4,265 / 6,4 m		bez pu	2,4	2,88
U10 - AL ukončovaci profil	10 x 19 mm	2,133 / 3,2 m 4,265 / 6,4 m		bez pu	1,58	1,90
U16 - AL ukončovaci profil	16 x 19 mm	4,265 / 6,4 m		bez pu	1,75	2,10
U20 ok. - AL ukončovaci profil	20 x 30 mm	2 / 3 / 6 m		bez pu	2,98	3,58
U25 ok. - AL ukončovaci profil	25 x 30 mm			bez pu	3,18	3,82
U32 ok. - AL ukončovaci profil	32 x 30 mm			bez pu	3,46	4,15
H10 - AL spojovací profil	10x13,5x60 mm	2 / 3 / 6 m		bez pu	7,22	8,66
H16 - AL spojovací profil	16x19,5x60 mm			bez pu	7,85	9,42
F10 - AL predĺžený profil	47 x 40 mm	2 / 3 / 6 m		bez pu	5,77	6,92
F16 - AL predĺžený profil	53 x 40 mm			bez pu	6,32	7,58
AL L25x25x2	25 x 25 x 2 mm	2,133 / 3,2 m 4,265 / 6,4 m		bez pu	3,18	3,82
AL L60x20x2	60 x 20 x 2 mm			bez pu	5,15	6,18
AL L60x40x2,6	60 x 40 x 2,6 mm			bez pu	8,45	10,14
AL RP60x40x2,5 (jokel)	60 x 40 x 2,5 mm	3 / 6 m		bez pu	15,81	18,97
GUMA 15, EPDM spodné tes.	50 mm	balík 30 m (bm)		čierna	1,35	1,62
GUMA 16, EPDM spodné tes.	60 mm	balík 30 m (bm)		čierna	1,66	1,99
GUMA 18, EPDM spodné tes.	80 mm	balík 30 m (bm)		čierna	2,00	2,40
Spodná GUMA 60	60 mm	balík 150 m (bm)		čierna	1,16	1,39
Pás GUMA 70	2 x 70 mm	balík 30 m (bm)		čierna	1,56	1,87
EPDM K - biela, samolepiace	tesnenie 10 x 4 mm	balík 100 m (bm)		biela	0,46	0,55

platnosť od:

11.4.2022



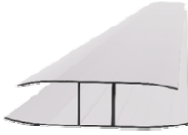

Radoslav Martoš - PPProdukt, Suchý potok 575/2, 972 42 Lehota pod Vtáčnikom

kód	rozmer	dĺžka	obrázok	farba	EUR/m ² bez DPH	EUR/m ² s DPH
POLYKARBONÁTOVÉ PROFILY s UV ochranou						
U-4-clear	4x13 mm	2,1 m		číra	0,84	1,01
U-6-clear	6x17 mm	2,1 m		číra	0,87	1,04
U-8-clear	8x18 mm	2,1 m		číra	1,05	1,26
U-10-clear (aj bronz)	10x19 mm	2,1 m		číra, bronz	1,20	1,44
U-16-clear	16x26 mm	2,1 m		číra	1,82	2,18
H-4-clear	4x65x55 mm	2 / 3 / 6 m (*7 m)		číra	2,30	2,76
H-6-clear	6x65x55 mm			číra	2,71	3,25
H-8-clear	8x70x62 mm			číra	2,93	3,52
H-10-clear* (aj bronz)	10x71x61 mm			číra*, bronz	2,85	3,42
H-16-clear	16x80x70 mm			číra	3,87	4,64

SPOJOVACÍ MATERIAL, tmel

Skr. 6,3 x 32	Samovrt. Skr. 6 hr., 6,3 x 32 mm DIN 7504-K		zínok	0,12	0,14
Skr. 6,3 x 38	Samovrt. Skr. 6 hr., 6,3 x 38 mm DIN 7504-K			0,12	0,14
Skr. 6,3 x 45	Samovrt. Skr. 6 hr., 6,3 x 45 mm DIN 7504-K			0,15	0,18
Skr. 6,3 x 50	Samovrt. Skr. 6 hr., 6,3 x 50 mm DIN 7504-K			0,17	0,20
Skr. 6,3 x 60	Samovrt. Skr. 6 hr., 6,3 x 60 mm DIN 7504-K			0,19	0,23
Skr. 6 x 60	Skrutka do dreva., 6H hlava, 6 x 60 mm		zínok	0,13	0,16
Skr. 6 x 70	Skrutka do dreva., 6H hlava, 6 x 70 mm			0,14	0,17
Skr. 6 x 80	Skrutka do dreva., 6H hlava, 6 x 80 mm			0,14	0,17
Skrutka do kotvy IZ 4 x 35 A2	VRDTP vrut, nerez, pologuťatá hlava kríž PZ		nerez	0,17	0,20
Kotva do izolácie 18x50 - šedá	plastová hmoždina do zateplenia		čierna	0,54	0,65
PGA16/7	Nerezová podložka s gumou, D16 / d7 mm		nerez čierna	0,16	0,19
PGA19/7	Nerezová podložka s gumou, D19 / d7 mm			0,16	0,19
PGA29/7	Nerezová podložka s gumou, D29 / d7 mm			0,42	0,50
PL krytka 6HR-10	Na skrutku + podložku D16		čierna	0,09	0,11
PC-PR-10-b (h)	Prítlačná príchytka D50/d6,5 mm, s PE tesnením		biela hnedá	0,80	0,96
Silikon OS S72	Transparentný silikónový tmel, objem 310 ml		transparent	12,17	14,60
Silikon A9 BAS	Transparentný silikónový tmel, objem 310 ml		transparent	8,61	10,33

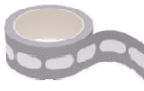
UKONČOVACIE MONTAŽNE PÁSKY

označenie	Pre hrúbku platne	ŠÍRKA PÁSKY	balenie bm/kot.	Popis	obrázok	farba	EUR/j. bez DPH	EUR/j. s DPH
TP G4628	4,5 - 6 - 8 mm	28 mm	50	TP bez filtra / nie je papierový nosič Antidust®		šedá	9,36	11,23
TP G4638	10 - 16 mm	38 mm	50			šedá	13,40	16,08
TP G4642	16 - 20 mm	42 mm	50			šedá	15,19	18,23
TP G4650	25 mm	50 mm	50			šedá	18,49	22,19
TP G3628	4,5 - 6 - 8 mm	28 mm	33	TP bez filtra / papierový nosič Antidust®		šedá	7,64	9,17
TP G3638	10 - 16 mm	38 mm	33			šedá	11,50	13,80
TP G3642	16 - 20 mm	42 mm	33			šedá	13,12	15,74
TP G3650	25 mm	50 mm	33			šedá	15,26	18,31
TP G3660	32 mm	60 mm	33			šedá	18,33	22,00
TP G3675S	40 mm	75 mm	33			šedá	28,78	34,54
TP AD3528	4,5 - 6 - 8 mm	28 mm	33	TP s filtrom/ papierový nosič Antidust®		šedá	22,10	26,52
TP AD3538	10 - 16 mm	38 mm	33			šedá	26,44	31,73
TP AD3542	16 - 20 mm	42 mm	33			šedá	29,11	34,93
TP AD3550	25 mm	50 mm	33			šedá	36,57	43,88
TP AD3560	32 mm	60 mm	33			šedá	49,56	59,47
MB28	4,5 - 6 - 8 mm	28 mm	33			TP priedušná/ papierový nosič MaxBreather		tmavošedá
MB38	10 - 16 mm	38 mm	33	tmavošedá	9,44			11,33

REZANIE, služby	Rezanie profilov	prerezanie profilu, +/- 3 mm	0,60	0,72
	Rezanie PP 2 - 6 mm	plné platne, +/- 3 mm	1,60	1,92
	Rezanie PP 8 - 15 mm	plné platne, +/- 3 mm	3,20	3,84
	Rezanie dĺžky KP do 7 m	komorové platne, +/-3 mm	0,95	1,14
	Rezanie šírky KP	komorové platne, +/-3 mm	1,60	1,92
	Rezanie dĺžky a šírky KP do 7 m	komorové platne, +/-3 mm	2,00	2,40
	Fukať 4 - 10 mm / BM	fúkať komorové platne, bm	0,30	0,36
	Fukať 16 - 40 mm / BM	fúkať komorové platne, bm	0,50	0,60
	Lepiť páskou /BM	zalepenie komôr mon. p. bm	0,35	0,42